

## Notice:

**Boehringer Laboratories, Inc. ceased production of 7700 Series Suction Regulators. These suction regulators have been replaced by the 7800 Series Suction Regulators.**

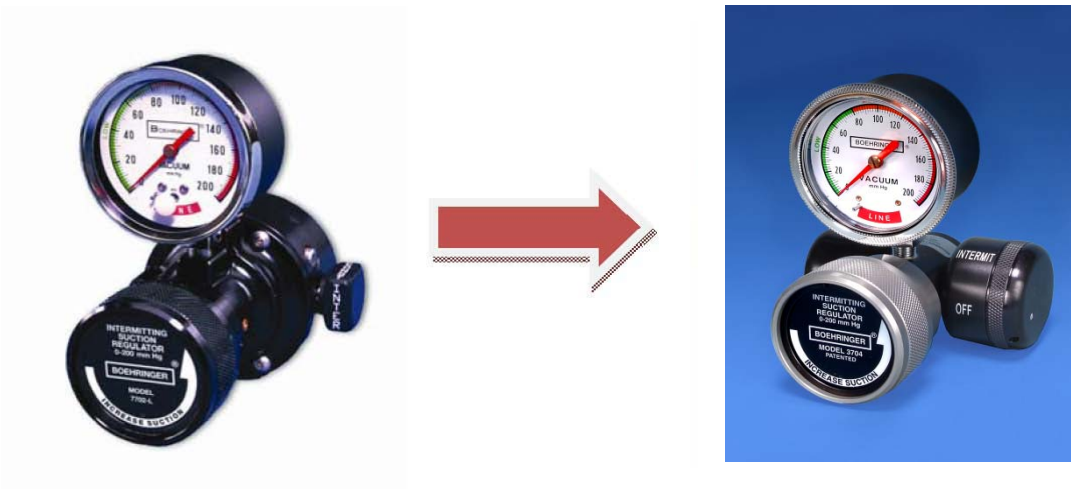

**Please contact your Boehringer Representative or the factory to learn more or request an evaluation of the 7800 Series Suction Regulators.**

**The 5 year warranty on your exiting 7700 units is still being honored, as well as most replacement parts for these units can be ordered from the factory.**

**These instructions for use should only be used for the information they contain on the servicing 7700 Series units, please refer to current instructions for use on the service of 7800 Series units.**



QUALITY AND SERVICE

# 7700 Series Suction Regulator Technical Manual and Operating and Maintenance Instructions



This Manual Covers Boehringer Regulator Models  
7700, 7701, and 7740

Congratulations on your purchase of a Boehringer Suction Regulator. We consider our Suction Regulators to be the best in the world. We are confident it will provide you with reliable, trouble-free, safe patient care and low cost of operation. This product is intended for use by individuals properly trained in suctioning procedures by or on the order of a physician. Please read these instructions carefully.

## **Table of Contents**

Contents.....	2
Warnings.....	3
Caution.....	3
Installation.....	3
Operation Continuous Models 7700, 7701 and 7740.....	3
Maintenance.....	4
Cleaning & Disinfection.....	4
<b>Continuous Models 7700, 7701, and 7740</b>	
Disassembly.....	4
Assembly.....	5
Test.....	5
Troubleshooting.....	6
Specifications.....	6
Warranty.....	7
Diagram, Continuous Models 7700, 7701, and 7740.....	8
Fittings/ Adapters.....	9
Accessories.....	10+

OBSOLETE / REFERENCE FOR 7700 SERIES ONLY

## **Clinical Use - All Models**

The 7700 Series Continuous Suction Regulators are designed to provide accurate control of wall suction for use in suction therapy procedures in the operating, recovery, intensive care unit, labor and delivery, neonatal, pediatrics, patient bedside, and emergency room.

## **Warnings - All Models**

This product is intended for use by or on the order of a physician. It is to be used by individuals who are properly trained in medical suctioning procedures. Please read these instructions carefully.

Suction regulators must only be attached to vacuum systems. Do not attach to compressed air, nitrogen, or oxygen sources.

Suction catheters, collection canisters and suction tubing must be carefully evaluated and selected to ensure adequate function for the specific clinical environment and intended field of use.

There have been reports of increased intracranial pressures associated with endotracheal suctioning procedures. "Persistent, increased ICP has been associated with neurological damage and fatalities". (Health Care Product Comparison Systems, Regulators, Suction, ECRI Plymouth Meeting, PA Oct'97).

## **Caution - All Models**

Always verify regulator operation (Droop) before use on a patient. "Droop" is the variation in indicated suction as flow in the collection circuit changes from an occluded condition to a free flowing condition. We measure droop as the change in indicated suction from no flow to full flow using a typical collection circuit with a 14 French catheter. Occlude the 14 Fr catheter, set the regulator to 100 mm Hg and then allow flow. The change in the indicated suction level is "Droop".

Intermitting Regulators: The automatic return of the patient circuit to atmosphere may not eliminate the need for catheter tip irrigation. As with any automatic system, it is important to monitor the results to be sure that drainage is occurring in a safe efficient manner. The fact that the intermitter is cycling is not an indication that effective drainage is occurring.

## **Installation - All Models**

All Boehringer suction regulators are supplied with 1/8" NPT female ports. This facilitates simple adaptation to any quick connect system. Most fittings are available from Boehringer to adapt to your quick connect system. Contact the factory for additional information.

1. Assemble desired male quick connect to the outlet on the back of the regulator using thread sealant.
2. Assemble the desired inlet fitting to the bottom of the regulator using thread sealant.

The regulator is now ready to be placed in service on your suction system.

Collection canisters are mandatory for all suction procedures. We strongly recommend the use of an overflow protection device (filter or trap bottle) at all times between the regulator and collection canister. See Accessories at the end of this manual.

## **Operation – Continuous Models 7700, 7701 and 7740**

Models 7700 and 7740 incorporate a 3-way control valve with OFF, REG, and LINE. Model 7701 does not have a control valve and constantly provides suction at the indicated level. The 7701 can be turned OFF by turning the adjusting knob all the way in.

**OFF:** With control valve in the OFF position, suction is off and the collection circuit is returned to atmospheric pressure by an internal vent port, a special feature of the Boehringer design.

**REG:** With control valve in the REG position, wall suction may be controlled to a specific level by turning the large adjusting knob in the direction indicated. A spring opposed diaphragm assembly precisely controls the level of suction provided at the lower port of the Regulator within the range of the gauge. This assembly "senses" changes

in the patient collection circuit and makes appropriate adjustments to maintain the suction level that has been selected. Regulated settings are verified by the large, easy to read gauge.

**LINE:** With control valve in the LINE position, the regulating mechanism is bypassed. Full wall suction is applied to the patient collection system through the lower port of the Regulator. The LINE suction mode is engaged by depressing the safety spring release and rotating the control valve to the line position. LINE setting is verified by the exposure of the "LINE" warning at the bottom of the gauge label.

**CAUTION: Full line suction may cause damage to sensitive tissue.**

### **Maintenance - All Models**

Boehringer Regulators have been designed to function for years of trouble-free service with minimum care. To determine the maintenance schedule your medical facility should follow, we recommend the following:

- Periodically (as required, but no less than annually) inspect the overall condition of the instrument. Test the gauge accuracy and check the instrument function as described under the Instrument Test section.
- Based on data from your periodic inspections, determine a cleaning schedule. Clean, inspect, lubricate, and test based on your schedule (at least annually) and according to the Instrument Cleaning and Disinfection, Instrument Lubrication and Instrument Test sections outlined below.

### **Cleaning and Disinfection - All Models**

The most significant cause of regulator failure is the lack of a comprehensive cleaning and maintenance program. For all models:

- At any time, the assembled regulator may be rinsed by drawing a 5% Liqui-Nox<sup>®</sup>/water solution through it. After flushing, aspirate air through the regulator for 1 minute, or until dry.
- In the event suctioned material should enter the Regulator, or a scheduled cleaning is required, follow the appropriate Disassembly procedures below.
- Regulators should be thoroughly cleaned and disassembled prior to any disinfection cycle.
- All regulator parts may be soaked in a solution of warm water and lab ware detergent such as Liqui-Nox<sup>®</sup> and scrubbed using a soft brush to remove proteinaceous deposits.

**Disinfection:** It is the responsibility of the Medical facility to perform the steps outlined in this procedure and to determine that the recommended cycles are providing an effective level of disinfection for the particular device in use.

After cleaning, any of the following procedures are acceptable modes of disinfection for all parts of the regulator, but not necessarily wall fittings. When disinfecting, be sure the device is disassembled and the wall fittings not included.

- EtO
- Cidex<sup>®</sup>
- Sterrad<sup>®</sup> (Cidex<sup>®</sup> and Sterrad<sup>®</sup> are registered trademarks of Johnson & Johnson)
- Autoclave

Reference Boehringer Labs Disinfection Procedure, 4100.018, for more detail.

### **Disassembly – Continuous Models 7700, 7701 and 7740 (fig. 1)**

1. Unscrew suction gauge (1) using a wrench. Do not twist the body of the gauge.
2. Back out lock screw (9) on housing assembly (8).
3. Unscrew diaphragm housing from Regulator body (13).
4. Remove valve retaining screw (10). Remove control valve (16).
5. In the unlikely event suctioned material should enter the diaphragm housing, it will be necessary to disassemble and scrub the unit as follows:
  - a. Remove quad ring (6), retaining ring (2), & lens cap (3).
  - b. Force out diaphragm (4) by pressing on piston/stem assembly (5). Remove piston/stem assembly (5) & spring (7).

**IMPORTANT:** Always clean the parts prior to assembly. See the Cleaning and Disinfection section for details.

### **Assembly and Lubrication – Continuous Models 7700, 7701 and 7740 (fig. 1)**

After disassembling and cleaning the instrument, assemble and lubricate as follows. Parts are available from Boehringer Labs and may be ordered by part number (P/N). Part numbers are found in figure 1 at the end of this manual.

1. Lubricate control valve (16) with synthetic lubricant (P/N 1895)
2. Rotate valve as you insert it into the body. Remove the valve and inspect for dry areas. The valve must have a thin layer of lubricant over its entire diameter.
3. Lubricate housing threaded sleeve and U-cup with a light coat of synthetic lubricant (P/N 1895)
4. Assemble diaphragm housing in reverse order of disassembly.
5. Inspect quad ring seal (6) for cuts or wear. Replace if needed (P/N 1461)
6. Assemble unit in reverse order of disassembly.

**IMPORTANT:** Always clean the parts prior to assembly. See the Cleaning and Disinfection section for details.

### **Test – All Models**

1. With the control valve in the REG or CONST position and a collection system attached with a 14 Fr. catheter, regulator should control vacuum from 10-100% of full scale.
2. With the control valve in the REG or CONST position and housing turned all the way off, with suction port occluded, gauge should read zero.
3. With the control valve in the REG or CONST, adjust regulator to the middle of the scale and occlude the catheter. Gauge movement should be less than 5% of the full scale of the regulator. This measurement is called droop.
4. The gauge should be accurate to  $\pm 4\%$  of FS for any measurement within the range of the scale. If this is not the case, please return the gauge to the manufacturer for repair/replacement.

**CAUTION:** Inaccurate gauge calibration may lead to a high suction condition applied to the patient.

5. With the control valve in the OFF position, suction should be at atmospheric and gauge should read zero. With suction port occluded, gauge should read zero.
6. With the control valve in the REG or CONST position, set the Regulator to the middle of the scale and turn control valve to OFF, then back to REG or CONST. Gauge indicator should not travel more than 20% past the set point before settling at the desired level.
7. With the intermitter control valve in the INTERMIT position, the cycle time should be about 8 seconds on and 4 seconds off (at 500 mmHg supply) *or as desired*. Adjust the timing screw CW to speed up the cycle time and CCW to slow down the cycle time.
8. A final, important step in instrument maintenance is the identification of the instrument. This confirms that a qualified individual performed service to accepted procedures and approved master gauges. An ID tag should accompany the instrument, which indicates (as a minimum): date of service, individual performing the service and the date of next service.

**CAUTION:** Have the regulator factory serviced if not performing to specifications. See Warranty and Repair section for details on getting your regulator factory serviced.

**IMPORTANT:** Always test the reassembled unit after each maintenance procedure. See the Test section below for exact test procedure.

## **Troubleshooting- All Models**

Boehringer Suction Regulators have been designed for years of trouble-free service. Should you experience difficulty that is not the result of damage to the instrument, the most likely cause is aspiration of dirt and/or fluids into the Regulator.

<b>Symptom</b>	<b>Probable Cause</b>	<b>Solution</b>
Instrument fails to provide suction at the patient port.	The supply or patient fittings are clogged	Replace or clean the fittings
Sluggish, stuck or non-functioning gauge	Gauge orifice is clogged	Remove gauge and clean orifice with .016" diameter wire
Instrument will not shut off or exhibits high droop	Dried fluids may have cut the quad ring seal.	Replace the quad ring and test the unit as per above procedure.
Instrument fails to regulate suction	Piston/Stem surface is binding with foreign matter	Disassemble and clean the instrument.
Erratic gauge movement resulting from regulator adjustment	Dried fluids on the piston/stem	Clean fluids/debris off of stem and piston

**IMPORTANT:** Always test the reassembled unit after each maintenance procedure. See the Test section for exact test procedure.

## **Specifications – All Models**

- All Boehringer regulators are designed and manufactured in the U.S.A.
- Inlet and outlet fittings: 1/8 NPT
- Gauge accuracy  $\pm 4\%$  FSO
- Regulation Accuracy:  $\pm 10\%$  F.S. from full flow to zero flow with 14 FR catheter attached.
- Leak rate in OFF position: less than 1 cc/min
- Free Air Flow: Greater than 38 LPM with regulator set to 100 mmHg at standard JCAHO supply (305mmHg @ 180 SCFH).
- Materials: polycarbonate, hard-anodized aluminum, stainless steel, Buna rubber, acetal copolymer.

Model	Regulation Range	User Selectable Modes	Wt. (lb)*	H x W x D (in)
7700	20-200 mm Hg	Off / Regulated Control, Line (source vacuum)	1.25	5 x 2 $\frac{3}{4}$ x 4
7701	20-200 mm Hg	Regulated Control (no control valve)	1.25	5 x 2 $\frac{3}{4}$ x 4
7740	70-760 mm Hg	Regulated Control (no control valve)	1.25	5 x 2 $\frac{3}{4}$ x 4

\*Regulator weights are without fittings.

## **Operating and Storage Limits – All Models**

We recommend that Boehringer Suction regulators be operated and stored at controlled conditions that typically reflect the medical facility environment.

## Warranty and Repair – All Models

Boehringer Laboratories, LLC guarantees all 3700 Series LONG LIFE Suction Regulators for TEN years. The 7700 Series Suction Regulators have a FIVE year warranty with the exception of the gauge which has a one year warranty. Boehringer Laboratories, LLC will also warrant all fittings purchased from and installed by Boehringer Laboratories, LLC for the same warranty period as the suction regulator on which they were originally installed.

Boehringer Laboratories, LLC warrants to the original purchaser, new suction regulators purchased directly from Boehringer Laboratories, LLC or from an authorized dealer or representative. This warranty guarantees the suction regulators to be free from functional defects in materials and workmanship. We also guarantee that our suction regulators will meet our published specifications.

All regulators returned for repair shall be clean and free from contamination prior to shipment to Boehringer Laboratories. This requirement is for the safety of our employees as well as to comply with Federal Law prohibiting the shipment of unmarked biohazard materials. If units are returned contaminated, a cleaning charge may result.

A service charge may be assessed on any unit returned that shows evidence of gross abuse.

Boehringer Laboratories, LLC is the only authorized warranty service center for our suction regulators. Any repair service requesting a return authorization for repair will be asked to provide the name and location of the original equipment purchaser. If this information cannot be provided, the repair is not covered under warranty and will be a chargeable repair.

This warranty excludes acts of God, fire, flood and acts of war, terror or insurrection.

This warranty is not transferable from the original purchaser.

Boehringer Laboratories' sole and exclusive remedy under this warranty is limited to repairing and/or replacing the suction regulator. There are no other express or implied warranties beyond these warranties set forth above.

***At Boehringer Laboratories, we are committed to lowering your suction regulator costs of operation!***



*All repairs will be shipped back within five days of receipt of purchase order authorization.*

For quality factory service, call 800-642-4945 or 610-278-0900 for your return authorization. Ship returns to:

**Boehringer Laboratories, LLC  
Repair Department  
500 E. Washington Street  
Norristown, PA 19401**

### New Products

We are continually striving to reach higher and higher standards of quality. We value your comments and input on our suction regulators. If you are pleased with this instrument, please find out more about Boehringer Laboratories' complete line of suction controls.

***A free trial evaluation of any of our suction regulators can be arranged  
by calling (800) 642-4945 or 610-278-0900.***





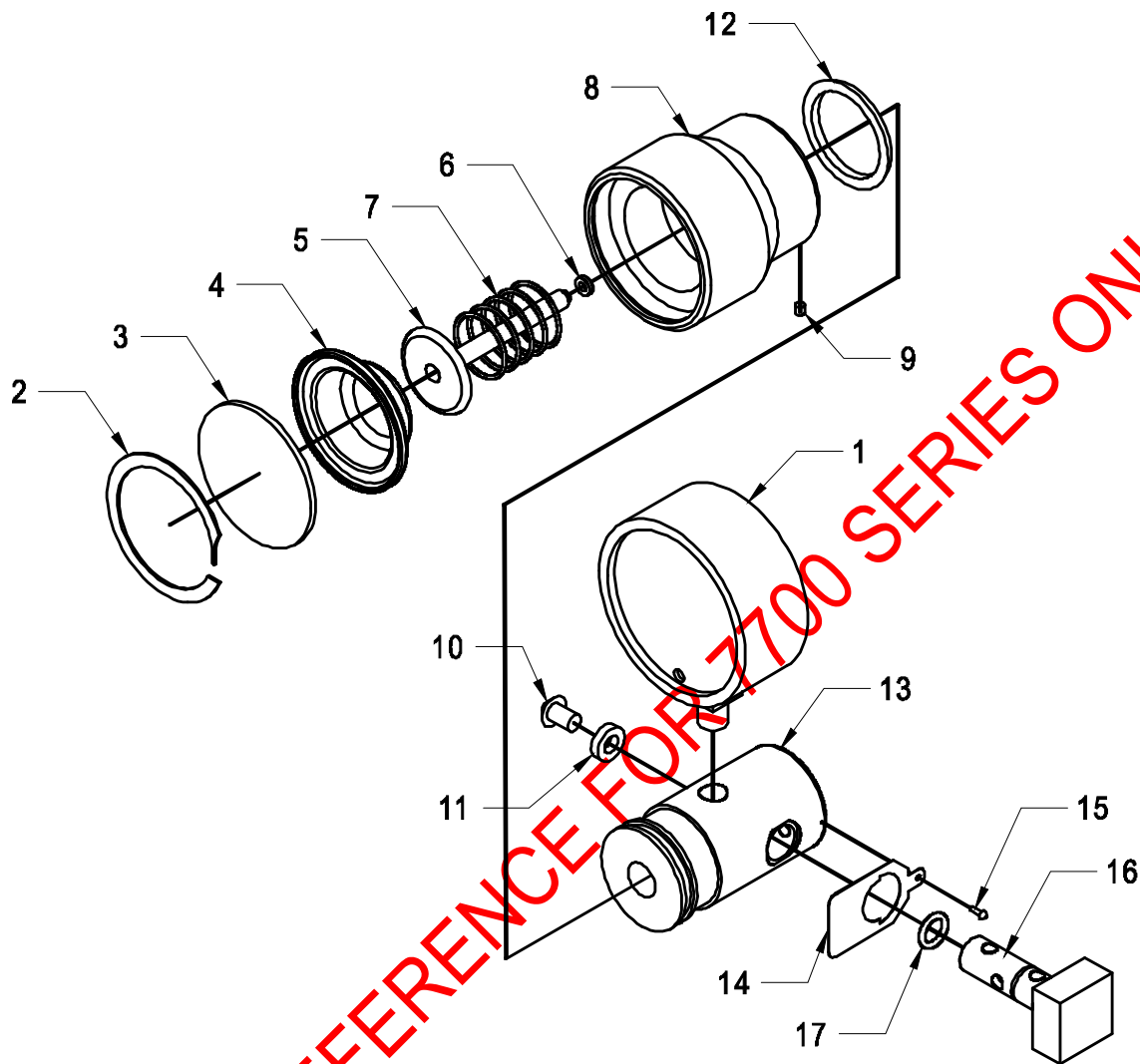



**FIGURE 1 – Models 7700 (pictured), 7701 and 7740**



<u>No.</u>	<u>P/N</u>	<u>Description</u>	<u>No.</u>	<u>P/N</u>	<u>Description</u>
1	9071	0-200 mmHg Gauge (7700, 7701)	8	2300	Diaphragm Housing Assembly
1	9072	0-100 mmHg Gauge (7970)	9	1479	Lock Screw
1	9073	0-760 mmHg Gauge (7740)	10	1468	Control Valve Retaining Screw
2	1465BF	Lens Cap Retaining Ring	11	1454	Control Valve Retaining Washer
3	1981	Lens Cap (7700)	12	1484	U-cup
3	1982	Lens Cap (7701)	13	1458HC	Reg Body <sup>1</sup> (7700, 7740)
3	2281	Lens Cap (7740)	13	1774HC	Reg Body <sup>1</sup> (7701, 7970)
3	2042	Lens Cap (7970)	14	1462	Thumb Spring
4	1466	Regulating Diaphragm	15	1480	Thumb Spring Retaining Screw
5	2297	Piston/Stem Assembly	16	1453HC	Control Valve <sup>1</sup> (7700, 7740)
6	1461	Quad Ring	17	353	Control Valve O-Ring
7	1464	0-200 mmHg Spring (7700, 7701)			
7	1501	0-100 mmHg Spring (7970)			
7	2278	0-760 mmHg Spring (7740)			

1. The Reg Body and Control Valve are factory matched. Please call for details on replacement.

## Suction Fittings & Accessories

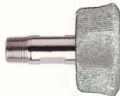
Location	Configuration requirement	Order Number and Description	
Patient Connection Port	Suction tubing attached directly to the suction regulator	Model 2469 High Flow Bubble Barb	
	Suction regulator attached to collection canister, rollstand or trap bottle	Model 1487 DISS Body Adapter	
Wall Adapter Port	 Vacuum outlet requires a 90° twist to release the regulator	Model 1492 Diamond Ohio	
	 Vacuum outlet has a button to release the regulator	Model 1493 Chemetron (NCG) Rectangular Adapter	
	 The adapter screws onto the outlet and then is unscrewed to remove (approximately 3 turns)	Model 1504 DISS Hand-Tight Nut and Gland	

### Other Fittings Available

P/N	Description	P/N	Description
905	90° Street Elbow	2098	Y-Connector
1494	NCG Round Adapter	2147	1/8" NPT Hex Nipple
1495	Schrader Adapter	2164	1/8" x 1/8" NPT Fitting
1496	Puritan Adapter	2257	Female Hose Barb
1497	Oxequip Adapter	2468	45° Elbow
1498	Medstar/Oxequip Adapter	9081	Medi-Vac Cart Mount
1505	DISS Wrench Nut and Gland	9084	Bulkhead Fitting – Sorenson Type (Medi-Vac)
1813	Right Angle Hose Barb	9089	Patient Tee Adapter
1975	1/8" NPT Coupler	33291	Pipe Nipple 1/8NPT x 1-1/2 Long
1977	DISS Barb Adapter		

*Please call 800-642-4945 or 610-278-0900 for special mounting applications and accessories.*

### Recommended Accessories ( to prevent clogging and contamination)



#### **Float Vacuum Safety Bottle – Model 9074**

This device will protect your regulators and suction system from fluid overflow. The bottle provides a 250 ml backup overflow volume with shut-off capability provided by a precision float mechanism.



#### **Inline Filter – Model 7791**

This device will protect your regulators and suction system from fluid overflow. It is a hydrophobic, high flow, 1.0 micron filter and can be EtO sterilized. The filter goes in the patient circuit between the waste canister and the regulator.



**SETTING THE STANDARD  
FOR RELIABILITY**

Boehringer Laboratories, LLC  
500 E. Washington Street  
Norristown, PA USA 19401

For  
Customer Service  
Or  
Technical Support

800-642-4945

[www.boehringerlabs.com](http://www.boehringerlabs.com)

email: [info@boehringerlabs.com](mailto:info@boehringerlabs.com)

Copyright 2004 Boehringer Laboratories, Inc.

European Representative:



Medical Product Service, GmbH  
Borngasse 20  
35619 Braunfels, Germany  
Tel: 49.6442.962073  
Fax: 49.6442.962074

***A free trial evaluation  
of any of our suction regulators  
can be arranged by calling  
(800) 642-4945 or 610-278-0900.***