

User Manual



BOEHRINGER®

Boehringer Laboratories, LLC
300 Thoms Dr.
Phoenixville, PA 19460
800-642-4945

*Model 3931
Vacuum Assisted Venous
Drainage Controller w/
WAGD Suction Flowmeter
and Vacuum Assist Protection
Circuit (VacPac™)*

WELCOME

Congratulations on your purchase of the Boehringer VAVD regulator. We consider our regulators to be the best in the world. We are confident it will provide you with reliable, trouble-free, safe patient care and low cost of operation. This product is intended for use by clinicians properly trained in the use of vacuum assisted venous drainage for cardiopulmonary bypass. The product is intended for use on the order of a physician. Please read these instructions carefully.

Contents

Definition of Terms	3
Indications	4
Contraindications.....	4
Safety Information	4
Operation/Features	6
Theory of Operation	7
Installation	7
Pre-Use Check	8
Clinical Use.....	8
Maintenance	8
Accessories	10
Cleaning & Disinfection	11
Troubleshooting.....	11
Specifications	11
Warranty and Repair	12

Definition of Terms and Symbology

- VACUUM** Air or other gases at a sub atmospheric pressure typically expressed as mmHg.
- SUCTION** A use of vacuum that causes a fluid or solid to be drawn into an interior space or to adhere to a surface because of the difference between the external and internal pressures.
-  Alerts the user to the presence of important operating and maintenance instructions in the literature accompanying the device.
- WARNING** Alerts user to actions or conditions that could result in injury to user or patient.
- CAUTION** Alerts user to actions or conditions that can cause damage to the device or may result in substandard performance of the device or system.
- IMPORTANT** Indicates an action that is emphasized to ensure proper operation of equipment.
- OFF** Suction is off and patient circuit is vented to atmospheric pressure.
- REG** Suction is on and regulated output is controlled via the Adjusting Knob.







Lo Spike: Accuracy of regulation depends primarily on the ability to provide a consistent level of vacuum under changing flow conditions. Pneumatic tissue damage can occur when high levels of vacuum are applied to delicate tissue. With a Boehringer regulator, you can depend on very low “spike” compared to our competitor’s models.





“Spike” is the variation in indicated suction as flow in the collection circuit changes from a free-flowing condition to an occluded condition. We measure spike as the change in indicated suction from full flow to a no flow condition using a typical collection circuit with a 14 French catheter. To test, set the regulator to 50 mmHg flowing, and then allow occlude the 14 French catheter. The change in the indicated suction level is “Spike”.

Boehringer regulators are checked on the assembly line to meet a specification of less than 10% of the indicated setting, for example 5 mmHg spike at a 50 mmHg setting.

An evaluation of a regulator’s spike allows one to determine whether the device is truly “regulating”. A safe and reliable regulator should regulate to its set position regardless of variable flow conditions.

- PARALLAX** Inaccuracy caused by observational position of an indicating element (pointer) to a reference element (scale).

	Found on IFU and packaging labels. Definition: Federal law restricts this device to sale by or on the order of a physician.
	Found on IFU and packaging labels. Definition: Sterile
	Found on IFU and packaging labels. Definition: Do not re-use.
	Found on IFU and packaging labels. Definition: This product is not made with natural rubber latex.

	Found on the IFU and packaging labels. Definition: Manufacturer.
	Found on packaging labels. Definition: Do not use if package is damaged.
	Found on packaging labels. Definition: Consult instructions for use.
REF	Found on packaging labels. Definition: Reorder number.
LOT	Found on packaging labels. Definition: Lot number.
	Found on packaging labels. Definition: Use-by-date.

Indications for Use

This product is intended for use by or on the order of a physician. It is to be used by individuals who are properly trained in the use of Vacuum Assisted Venous Drainage during Cardiopulmonary Bypass.

The Boehringer VAVD Controller was designed to provide accurate control of wall suction for use in vacuum assisted venous drainage and the removal of waste anesthetic gases in cardiac surgery. The VAVD provides a redundant safety device that vents positive pressure and excess negative pressure.

Contraindications

This device is designed and sold for use only as indicated.

Safety Information

WARNINGS AND PRECAUTIONS

R_x Only

- Federal law restricts this device to sale by or on the order of a physician or licensed practitioner. Use of this device should only be performed by persons having adequate training, familiarity with contemporary surgical techniques, and with the use of this device. Consult medical literature relevant to techniques, complications, and hazards prior to use of this device. Please read these instructions carefully.
- Braid reinforced connection tubing is included with this device and must be used to preclude the possibility of suction tubing collapse during extended periods of use. This tubing should have a vertical orientation to reduce the possibility of kinking over time. Any deformation may be indicative of a reduction in flow to the suction regulator and accompanying patient circuit.

- Always verify the regulator is attached to an appropriate source of suction and that suction is present before attaching to a patient collection circuit. This can be verified by turning the Mode Selector Knob to REG and then using the Adjusting Knob to increase suction. The presence of suction can be audibly heard from at the patient port of the regulator.
- Always verify regulator operation (Spike, see page 3 for details) before use on a patient. Verify operation by establishing the desired vacuum level with the collection circuit and suction catheter attached to the regulator. Occlude the suction catheter and note that the indicated vacuum does not rise by more than 10% of the original setting.
- Suction regulators must only be attached to vacuum systems. Do not attach to compressed air, nitrogen, or oxygen sources.
- Do not cover, obstruct, or occlude the inlet of the interrupter where it is labeled 'Do Not Occlude Vent'. Do not attempt to calibrate this safety device. Return to the factory for appropriate service.
- When used in conjunction with a venous return reservoir for cardiac bypass surgery: ensure that all air detection and control devices are in proper working order, all field suction pumps are clear and operating, and monitor and control the fluid levels within the reservoir to prescribed limits.
- Prior to activating the patient circuit ensure VacPac™ is properly attached to the bottom of the VAVD suction regulator with both the front and rear pins engaged so the collection jar is securely locked into place.



STERILE R



- VacPac™ is provided sterile by irradiation.
 - Do not use if package is open or damaged. Inspect the device to ensure it has not been damaged before use. Do not use if package is expired as sterility may be compromised.
 - Single patient use. Do not reuse, reprocess or autoclave VacPac™, as this action may compromise the safety, function, and integrity of the device. Dispose of VacPac™ per your facility's biohazardous waste disposal protocol.
- VacPac™ is not made with natural rubber latex
- DO NOT clamp VacPac™ tubing. Apply vacuum or vent circuit using the Mode Selector Knob only.
- When used for vacuum assisted venous drainage for cardiac surgery, ensure proper placement of cannulae and verify that venous drainage is properly occurring.
- Suction catheters, collection canisters and suction tubing must be carefully evaluated and selected to ensure adequate function for the specific clinical environment and intended field of use.
- The Suction Flowmeter of the 3931 uses the facility's medical-surgical vacuum source for Waste Anesthetic Gas Disposal (WAGD). As such, flammable anesthetics or other flammable vapors are required to be diluted below the lower flammable limit prior to disposal into the medical-surgical vacuum system per NFPA 99-2018 (5.1.3.8).

Operation

FEATURES

WARNING! – Safety Port:
Do Not Occlude

Independent Safety Relief:

1. **High Negativity Safety Vent:**
Safety mechanism limits maximum suction to less than 90 mmHg.
2. **Positive Pressure Relief:**
Safety mechanism vents excess positive pressure.

Supply Gauge:

Supply pressure drop allows for quick identification and correction of open caps or kinks in tubing.

Venous Drainage Gauge:

Allows accurate readings from 180° field of view and never requires calibration. Each range has unique color-coding.

Adjusting Knob:

Extra-large, easy grip knob turns COUNTER-CLOCKWISE to increase suction setting and CLOCKWISE to decrease suction setting.

Adjustable Bracket:

Allows mounting to vertical poles.

WAGD Suction Flowmeter:

For attachment to the scavenger port on the membrane oxygenator via the provided WAGD tubing with safety vents.

Venting Holes:

The WAGD tubing assembly has built in holes at either end that allow for passive venting. No alteration of the tubing is necessary!

Vacuum Assist Protection Circuit:

(i.e. VacPac™), forms the sterile connection between the VAVD controller and the cardiotomy reservoir.

Mode Selector Knob:

Square knob to easily switch between operating modes (OFF/REG).

Braid Reinforced Supply Tubing Connection:

This tubing (not shown) connects the VAVD controller via the rear bubble barb to the suction source while retaining an adequate suction pathway.

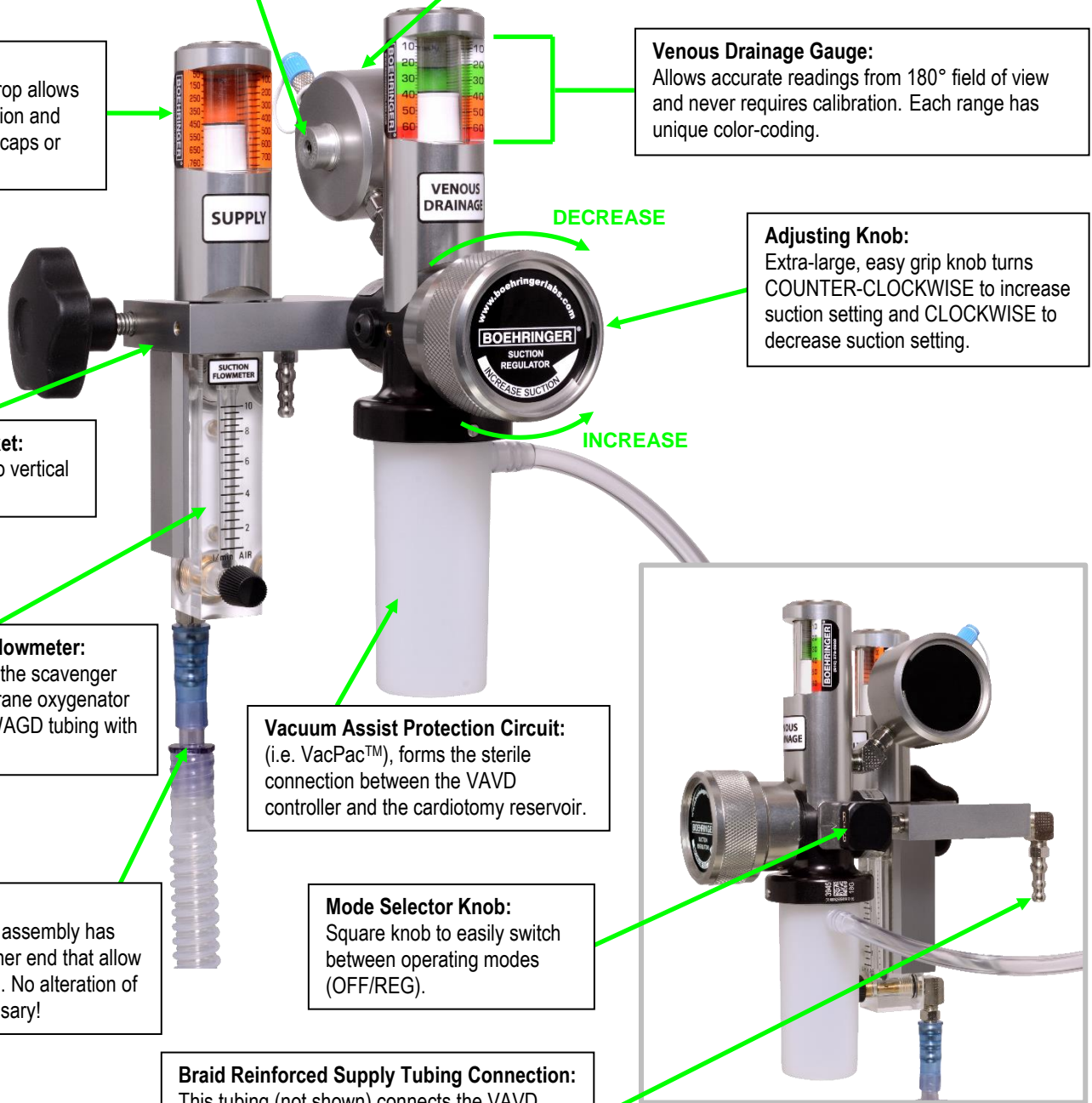

THEORY OF OPERATION / MODE SELECTION

The VAVD regulator incorporates a 2-way selector valve for selecting no suction or a user selected level of suction.

OFF Mode: When the Mode Selector Knob is in the OFF position, the vacuum supply is discontinued, and the circuit is returned to atmospheric pressure via two proprietary 5mm vents on the rear of the vacuum controller. These open vents will relieve any excess positive or negative pressure generated in the cardiotomy reservoir.

REG Mode: When the Mode Selector Knob is in the REG position, supply vacuum is delivered to the control mechanism and regulated vacuum in the range of 15 mmHg - 60 mmHg can be delivered to the cardiotomy reservoir. Redundant positive and negative pressure relief mechanisms are part of the circuit when in the REG model.



With the Mode Selector Knob in the **REG** position, wall vacuum may be controlled to a specific level by turning the Adjusting Knob in the direction indicated. A spring opposed diaphragm assembly precisely controls the level of suction provided at the lower inlet port of the regulator. This assembly senses changes in the venous return circuit and makes appropriate adjustments to maintain the vacuum level that has been selected. Regulated settings are indicated by the Venous Drainage Gauge.

CAUTION! Use the Mode Selector Knob to discontinue vacuum. The knob has a dedicated 5 mm vent which not only discontinues vacuum, but also rapidly vents the collection circuit. Applying excessive force to the Adjusting Knob in an attempt to shut off the unit may damage internal components.

INSTALLATION

The VAVD regulator is supplied with braid reinforced tubing suitable for suction service and should be used when connecting to a central suction supply. Inappropriate tubing could lead to a reduction in flow and compromise patient safety. The tubing should exit the fitting in a downward vertical orientation to minimize the possibility of kinking the supply tubing over time. Connect the externally reinforced clear tubing to the WAGD connection (below). This line is meant to conduct waste gases without applying negative pressure to the blood or gas inlet of the oxygenator.

PRE-USE CHECK

1. With the Mode Selector Knob of the suction regulator in the OFF position and the valve on the suction flowmeter fully closed (clockwise), verify the Supply Gauge reads > 500 mmHg. If a minimum of 500 mmHg is not available, check the incoming supply tubing, or check the suction inlet to confirm it is compliant with the NFPA 99 standard.
2. Adjust the WAGD suction flowmeter to fully open (counterclockwise) and verify the flowmeter registers flow and that audible suction can be heard from the WAGD line. Ensure the Supply Gauge registers > 400 mmHg with the suction flowmeter fully open. If a minimum of 400 mmHg is not maintained, VAVD may not be effectively applied, resulting in patient risk. Check the suction inlet to confirm it is compliant with the NFPA 99 standard.
3. Connect the VAVD Controller to the cardiotomy reservoir. Turn the Mode Selector Knob to REG and adjust the output to 20 mmHg. Ensure suction can be audibly heard and the unit maintains the 20 mmHg set point.

If the unit is unable to pass the pre-use criteria, please contact Customer Service 800-642-4945 to have the unit returned for needed service/calibration.

CLINICAL USE

1. Remove VacPac™ from its sterile packaging.
2. Lock VacPac™ into place at the bottom of the VAVD Controller. Ensure the locking pins in the front and rear are fully engaged - this creates an airtight seal.
3. Connect the blue fitting at the end of the VacPac™ tubing to the suction port on an appropriate cardiotomy reservoir. Do not draw patient materials directly into this line. Any accumulated water vapor will be trapped in the reservoir of VacPac™.

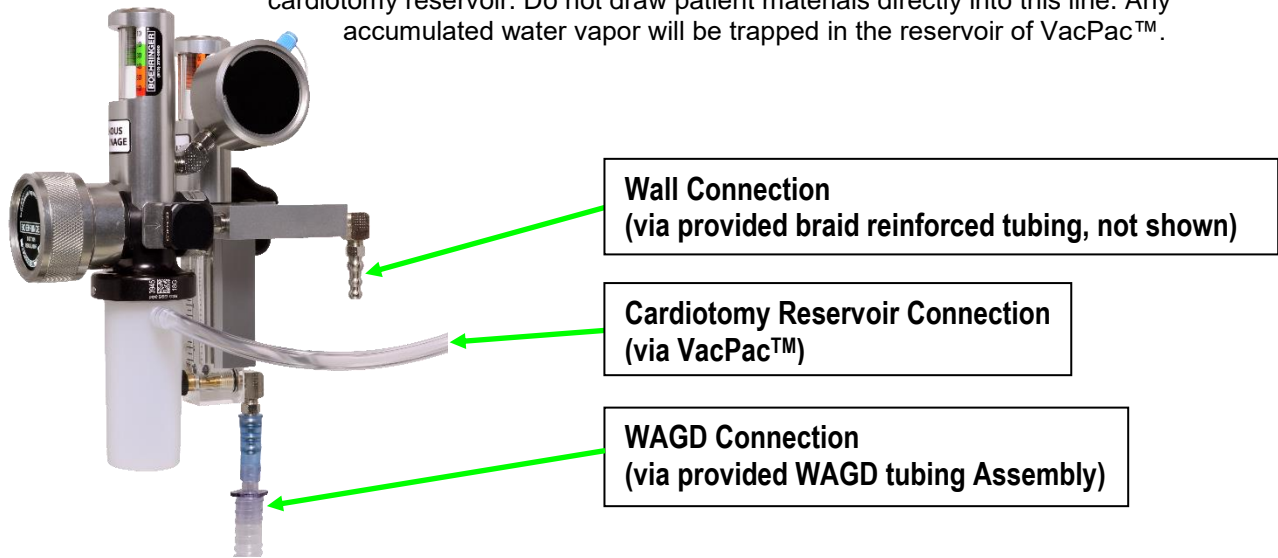

4. Turn the mode selector knob to REG. Listen for any leaks in the vacuum connections to the reservoir. If needed, re-seat the VacPac™ connector to address any leaks.
5. Follow venous reservoir manufacturer's instructions regarding proper set up and use.
6. Attach the externally reinforced clear tubing (WAGD Tube Assembly) to the vent port on the membrane oxygenator. The tube is bidirectional and either end may be connected to the vent port as well as the WAGD connection on the Suction Flowmeter. Do not block or occlude the vent holes that are at both ends of the tube. Do not modify the tubing in any way. Turn the suction flowmeter to at least 1 liter per minute above your sweep flow, or simply adjust the flowmeter to 8-10 liters per minute (any excess WAGD flow will be made up with room air through the vents).

MAINTENANCE

Your VAVD Controller has been designed with the highest quality materials and to the strictest production tolerances. Unlike common hospital suction regulators, the VAVD controller has precision low suction output and redundant safety features to limit excess negative and positive pressure. Given the critical nature of the clinical interventions in which the VAVD Controller is employed, and the inherent risk involved in applying unregulated suction during these procedures, only factory service and calibration may be performed on this unit.

Factory calibration is recommended - -

- Any time contaminated or biological fluid has entered the VAVD Controller.
- Any time there is physical damage noted to the VAVD Controller.
- Any time the VAVD Controller fails a pre-use test.
- A minimum of every 24 months.

While biennial factory calibration is strongly recommended at minimum, the calibration, excess vacuum relief, and positive pressure relief must be tested every other year to ensure the VAVD Controller remains in proper working order.

Calibration Testing

1. Attach the unit to a vacuum source which can achieve at least 400 mmHg of vacuum.
2. Connect to a mock circuit with a >1L reservoir and a pressure test gauge with a minimum of 0.25% Full Scale accuracy as can be seen below.
3. Set the unit to REG.
4. Test the VENOUS DRAINAGE Gauge accuracy at 10, 30, and 60 mmHg with the patient circuit fully occluded. The Venous Drainage and test gauges should read within 3 mmHg of one another at all three points. If the difference between the two readings is greater than 3 mmHg, send in for factory calibration.

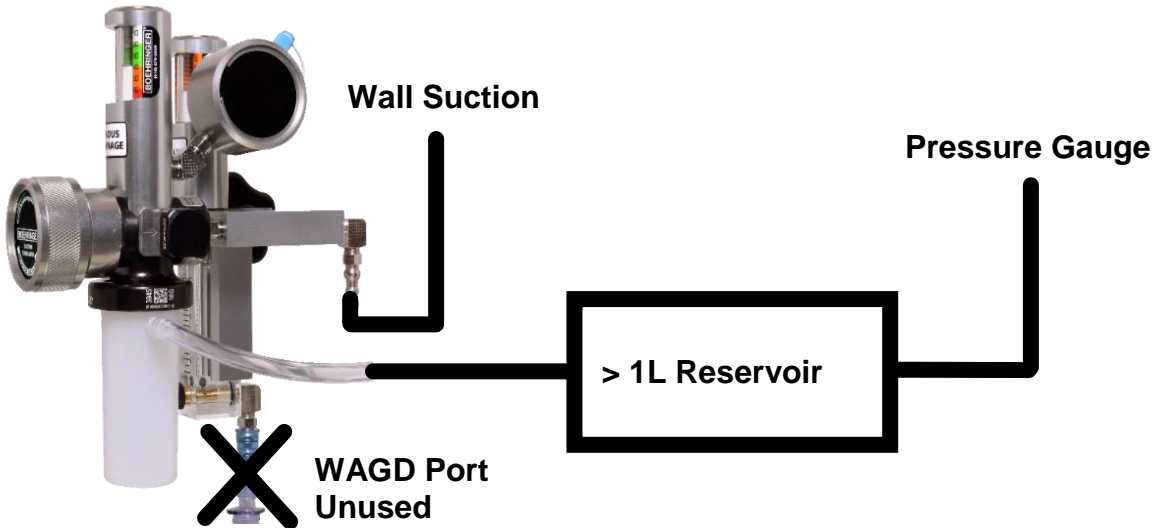

Excess Vacuum Relief Testing

1. Set the VAVD to REG and 40 mmHg.
2. Apply 10 LPM of excess suction to the mock patient circuit.
3. The test gauge should read between 75 and 90 mmHg. If the reading is outside of this range send in unit for factory calibration

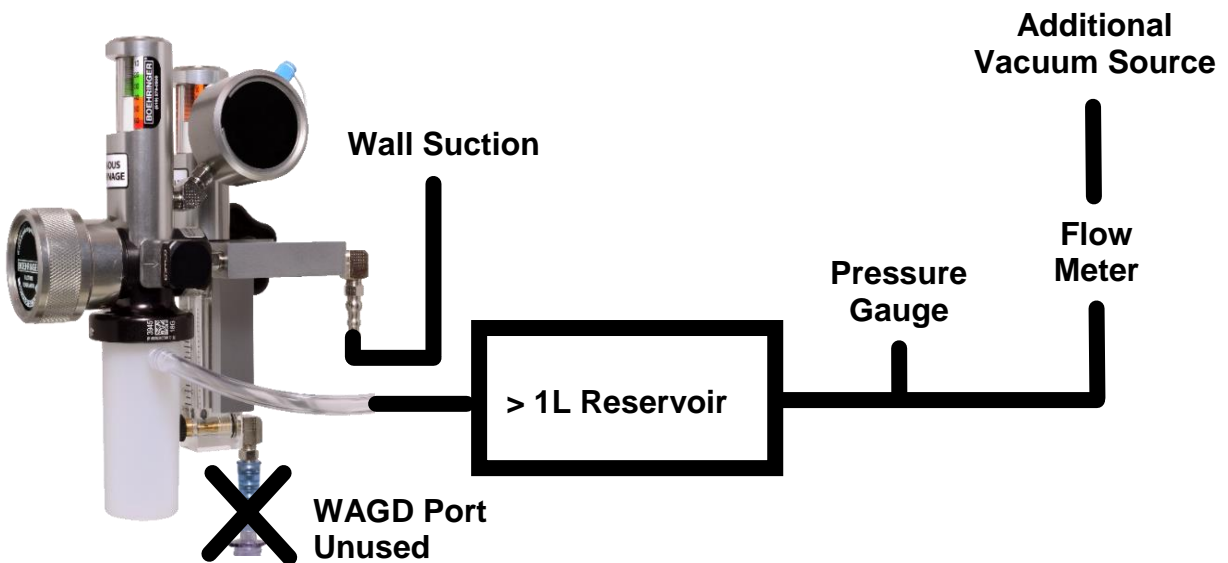

Positive Pressure Relief Testing

1. Disconnect VAVD from the mock circuit.
2. Set the VAVD to REG, and screw the diaphragm housing all the way in.
3. Connect a positive pressure source to the >1L reservoir of the device with a flow meter and pressure gauge in line. Reconnect VAVD to mock circuit.
4. Use the flow meter to adjust to 10 LPM of flow through the VAVD.
5. The test pressure gauge should read between 16 and 25 cmH₂O (note the different units). If the reading is outside of this range send in unit for factory calibration

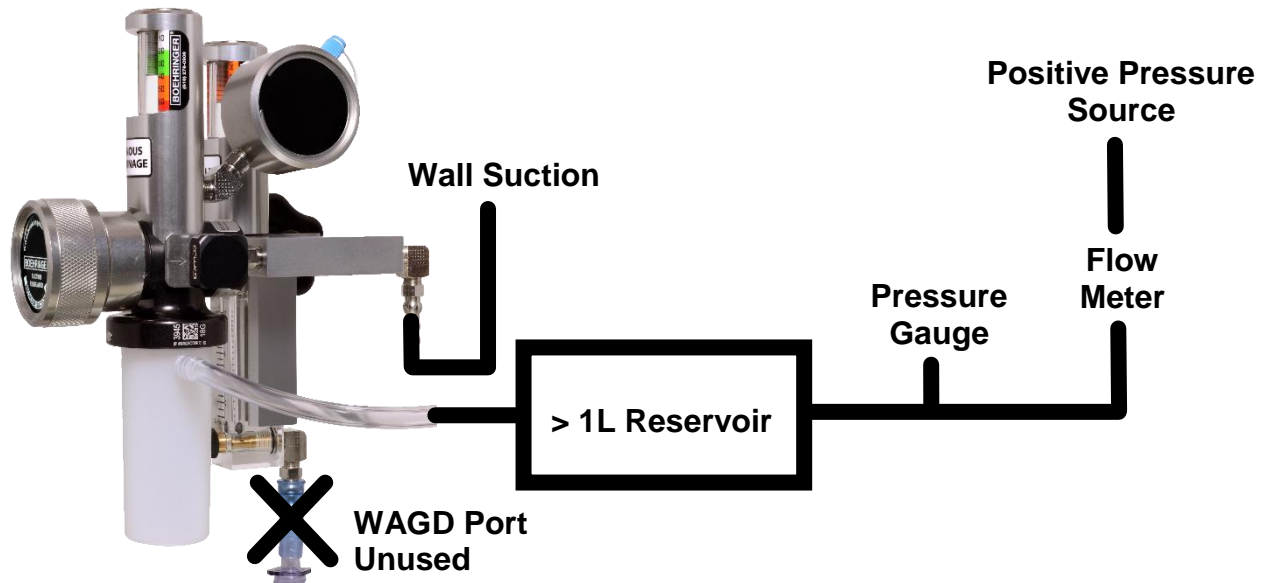

Accessories

WAGD Tube Assembly (Model 3947) - -

It is recommended to replace the WAGD Tube Assembly every (3) three months or sooner if it has any sign of being damaged or visibly contaminated. Order quantity of 1 unit.

Vacuum Assist Protection Circuit, VacPac™ (Model 3948) - -

Order quantity of 10 units.

Please call Customer Service at 800-642-4945 to order additional accessories or to obtain an RMA prior to unit return for service. Once your unit has been received you will be contacted with an estimate of any service charges. Units will be serviced within five days of receipt of charge authorization.

Cleaning & Disinfection

After patient use, wipe all exterior surfaces of the VAVD Controller with an appropriate surface disinfectant. Appropriate disinfectants are:

- 3M Quat®
- Cavacide®

TROUBLESHOOTING

Your VAVD regulator has been designed for years of trouble-free service. Should you experience difficulty that is not the result of damage to the instrument, the most likely cause is aspiration of dirt and/or fluids into the Regulator.

Symptom	Probable Cause	Solution
Instrument fails to provide suction at the cardiotomy reservoir port.	The supply or patient fittings are clogged, or the incoming suction tubing is collapsed or kinked.	Replace or clean the fittings. Replace the incoming suction line.
Gauge doesn't respond to changes in suction (via Mode Selector or Adjusting knob)	Gauge diaphragm is improperly sealed on the gauge piston and/or view tube	Reference Boehringer Tech Bulletin 3700.051.
Gauge piston is discolored.	Material has entered the inside of the device.	Instrument is contaminated. Please return to the factory for service.
Instrument will not shut off or exhibits high spike.	Dried fluids may have cut the quad ring seal.	Please return to the factory for service.
Instrument fails to regulate suction	Piston/Stem surface is binding with foreign matter	Please return to the factory for service.
Audible sound coming from safety port on safety interrupter	Material has entered the inside of the device.	Instrument is contaminated. Please return to the factory for service.

SPECIFICATIONS

Vacuum Assisted Venous Drainage Controller

- **Outlet Fitting:** 1/8 NPT, High Flow Bubble Barb (P/N 2469)
- **User Modes:** Off & Regulated control
- **Regulation Range:** 15 - 60 mmHg
- **Gauge Accuracy:** ANSI Class B, $\pm 5\%$ FS (± 3 mmHg)
- **Regulation Accuracy:** $\pm 10\%$ FS from full flow to zero flow with 14 FR catheter attached.
- **Materials:** polycarbonate, hard-anodized aluminum, stainless steel, Buna rubber, Acetal copolymer.
- **Weight:** 3.40 lbs.
- **Size:** 10¹/₄" x 7¹/₂" x 8¹/₂" (H x W x D)

Vacuum Assist Protection Circuit, VacPac™

- **Sterility:** Supplied sterile via gamma radiation
- **Size:** Jar: 2" height; Tubing: 4.5' length
- **Diameter:** Tubing: 3/8"
- **Collection Jar Volume:** 3 oz.
- **Material:** Jar: Low-Density Polyethylene (LDPE); Tubing: Polyvinyl Chloride (PVC)
- **Packaging:** SBS carton of 10 units, individually packaged in peel pouches
- **Shelf Life:** 2 years
- **Note:** VacPac is both BPA free and made with non-DEHP plasticizers. As such, it is compliant with The State of California's Proposition 65, the Safe Drinking Water and Toxic Enforcement Act

Operating and Storage Limits

We recommend that Boehringer Suction regulators be operated and stored at controlled conditions that typically reflect the medical facility environment.

Warranty and Repair

Boehringer Laboratories, Inc. guarantees your VAVD regulator for FIVE years from the date of manufacture.Boehringer Laboratories, Inc. warrants to the original purchaser, new suction regulators purchased directly fromBoehringer Laboratories, Inc. or from an authorized dealer or representative. This warranty guarantees the suction regulators to be free from functional defects in materials and workmanship. We also guarantee that our suction regulators will meet our published specifications.

All regulators returned for repair shall be clean and free from contamination prior to shipment. This requirement is for the safety of our employees as well as to comply with Federal Law prohibiting the shipment of unmarked biohazard materials. If units are returned contaminated, a cleaning charge may result.

A service charge may be assessed on any unit returned that shows evidence of gross abuse.

Boehringer Laboratories, Inc. is the only authorized warranty service center for your VAVD regulator.

This warranty excludes acts of God, fire, flood and acts of war, terror or insurrection.

Boehringer Laboratories' sole and exclusive remedy under this warranty is limited to repairing and/or replacing the suction regulator. There are no other express or implied warranties beyond these warranties set forth above. AtBoehringer Laboratories, we are committed to lowering your suction regulator costs of operation!

A Return Material Authorization Number (RMA) must be obtained prior to returning a unit for service. Please contact Customer Service at:

Boehringer Laboratories, LLC
800-642-4945
info@boehringerlabs.com
300 Thoms Dr.
Phoenixville, PA 19460
www.boehringerlabs.com

See our full list of patents here:
www.boehringerlabs.com/our-patents